

РАСКРАСКА МАЛЬШАМ

от ТОЧКИ к ТОЧКЕ



соедини точки,
раскрась картинку,
и впиши в клетки слово



КУРИЦА



ОСЬМИНОГ

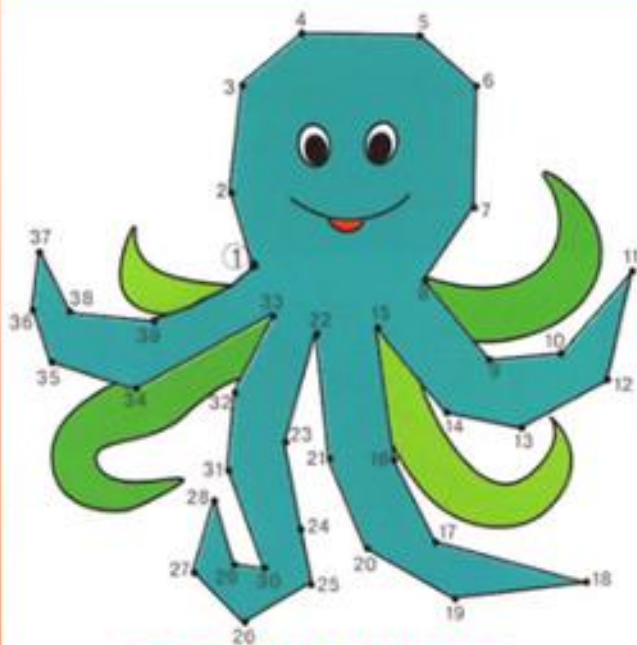

СЛОН

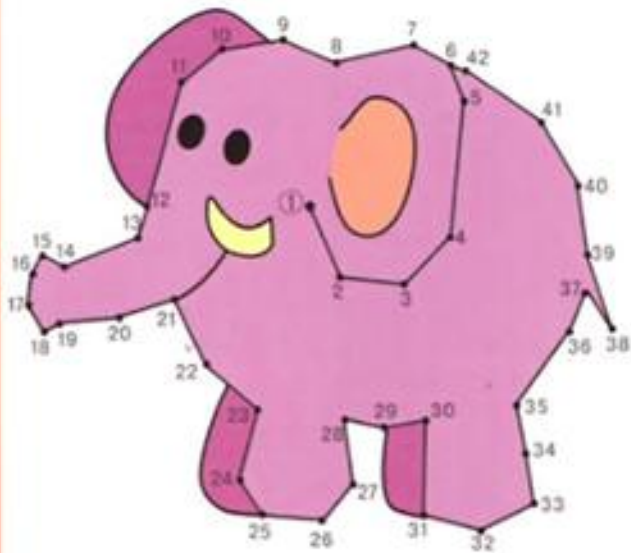

МЕДВЕДЬ

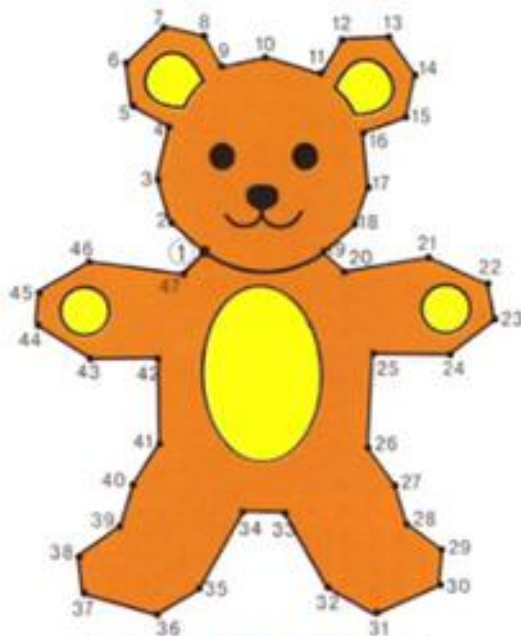

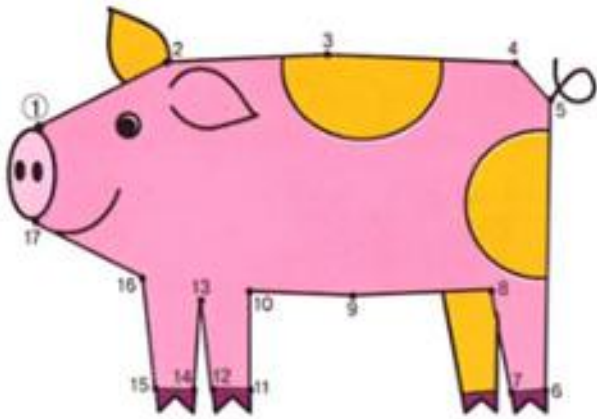

СВИНЬЯ

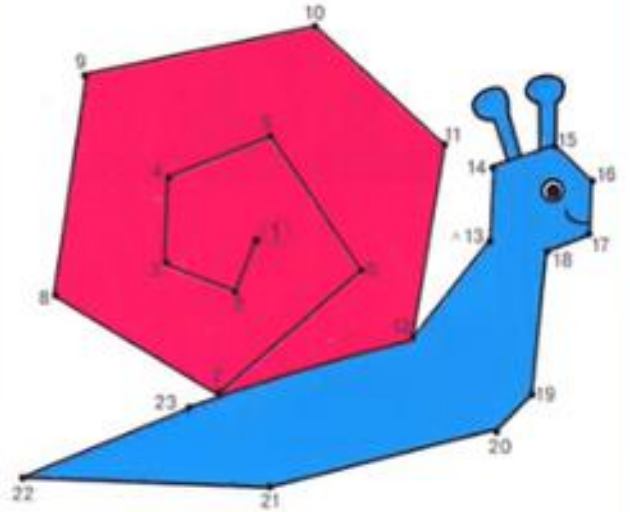

УЛИТКА

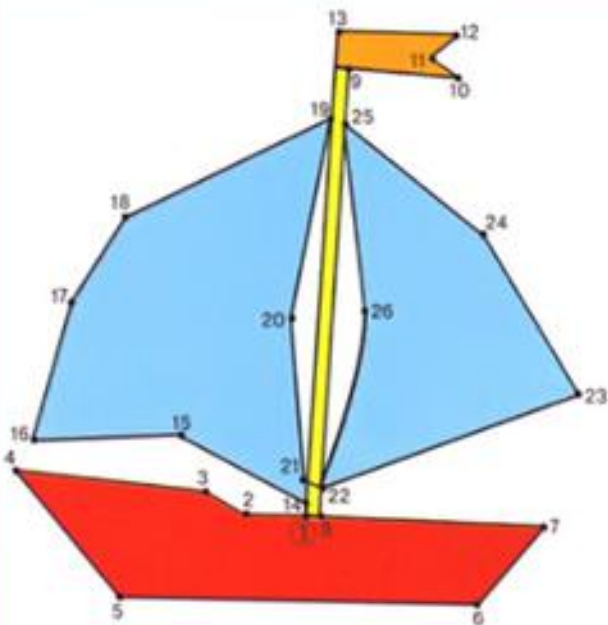

КОРАБЛИК

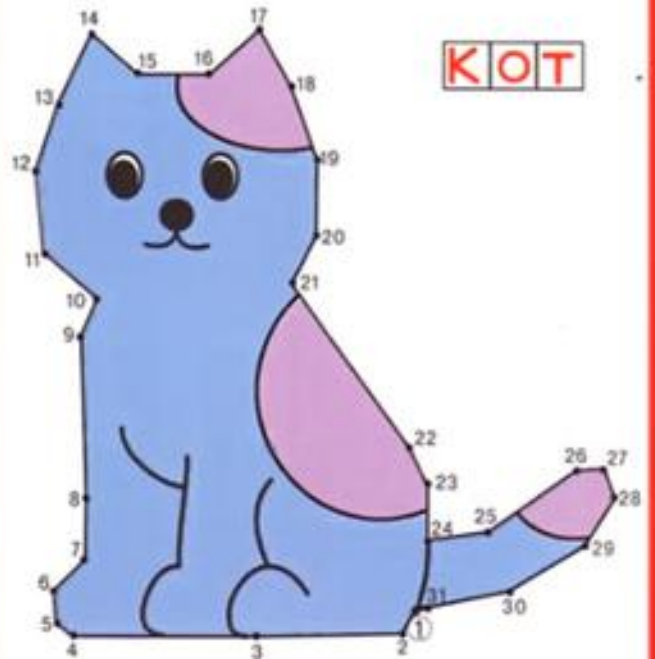

КОТ

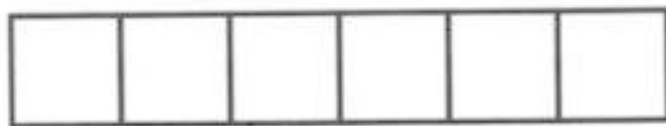
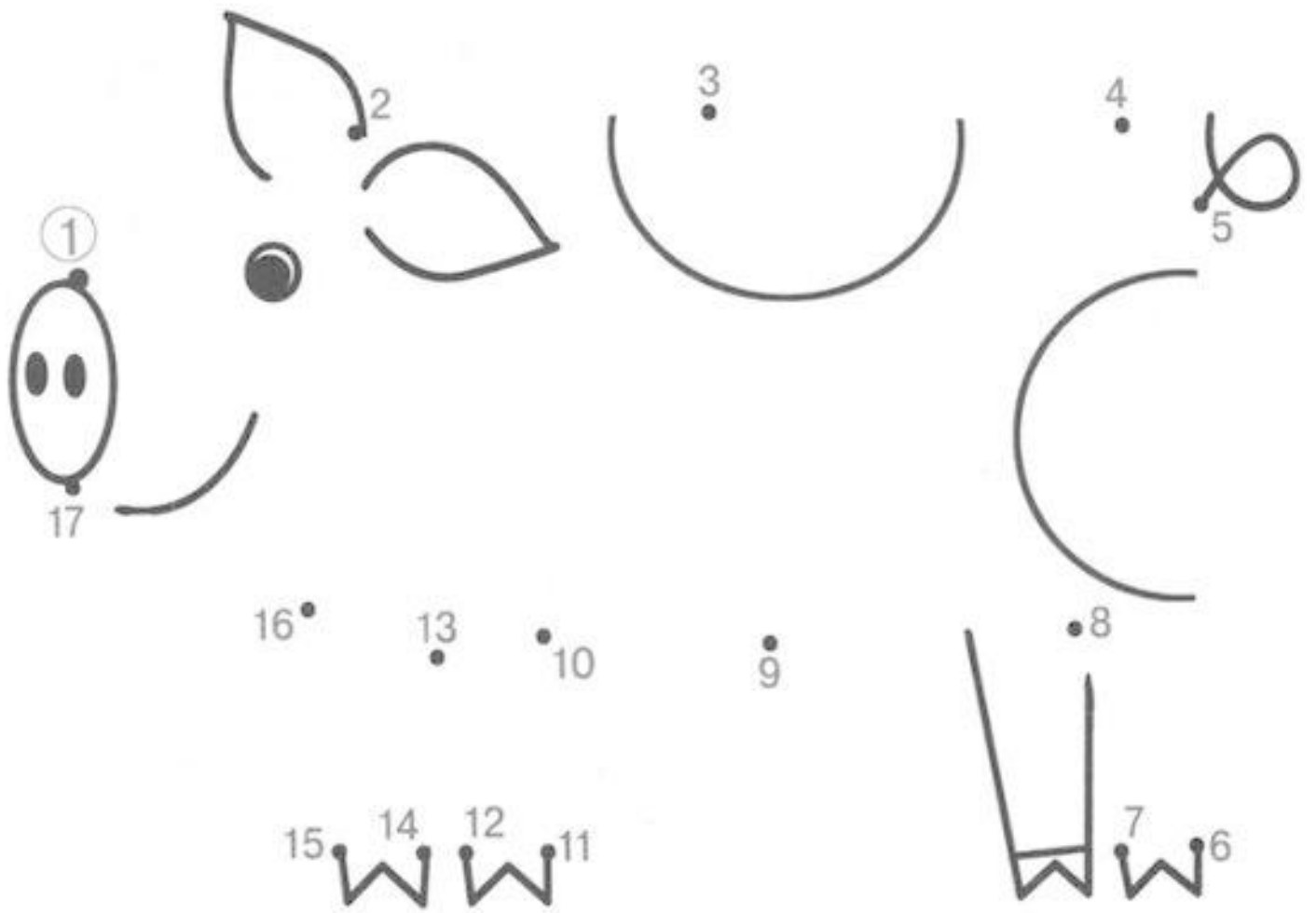

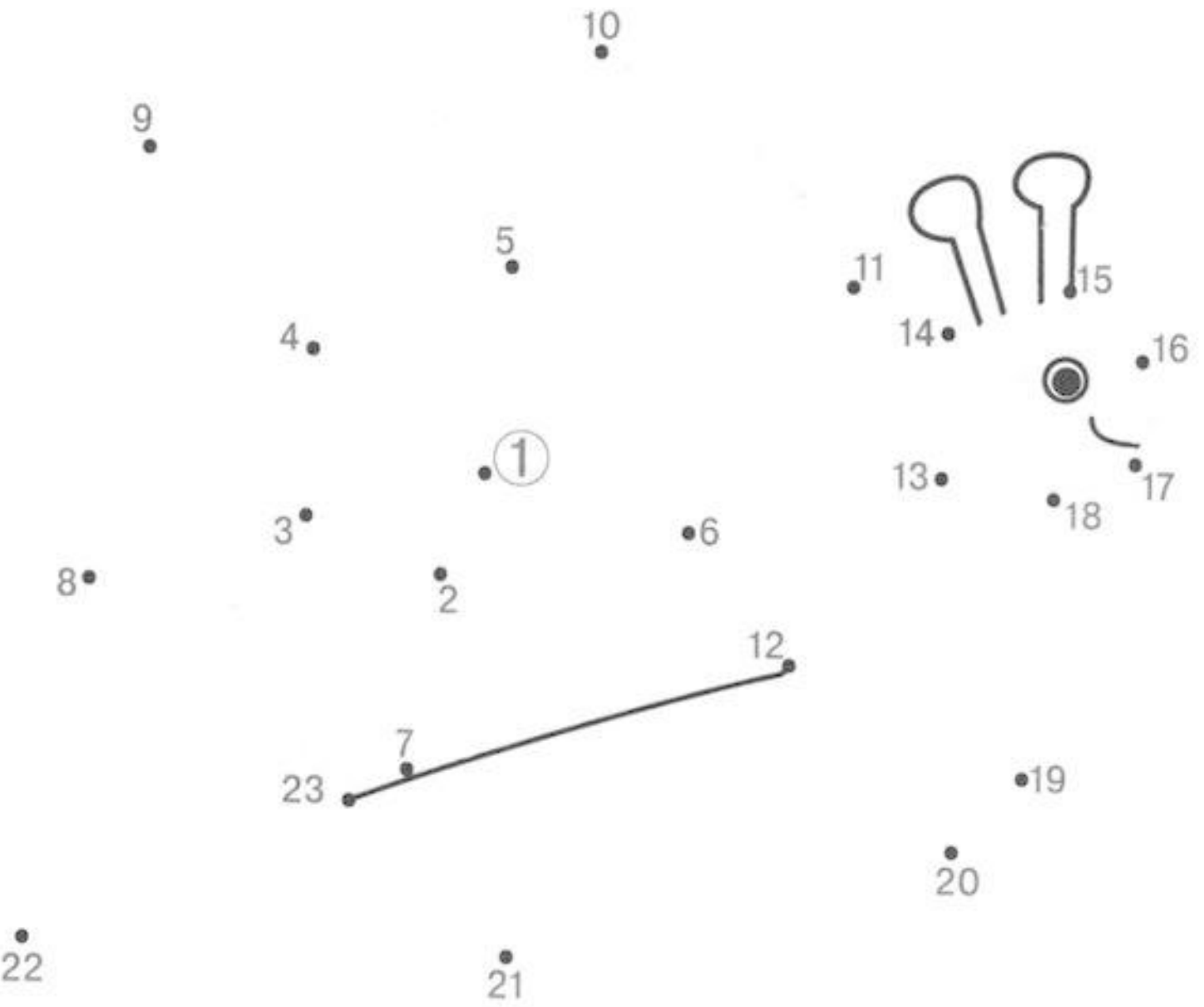

--	--	--	--	--	--

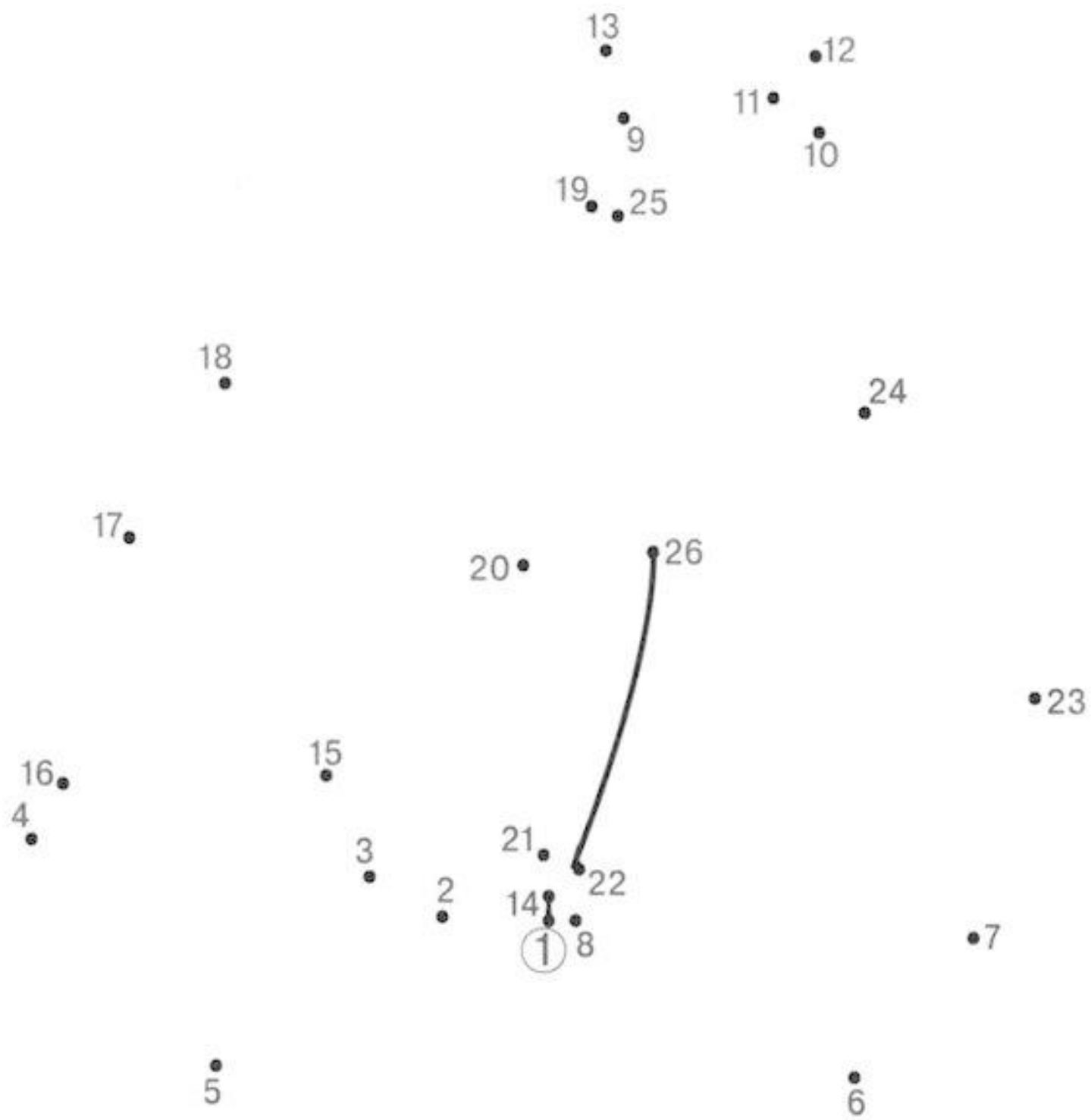

--	--	--	--	--	--	--	--

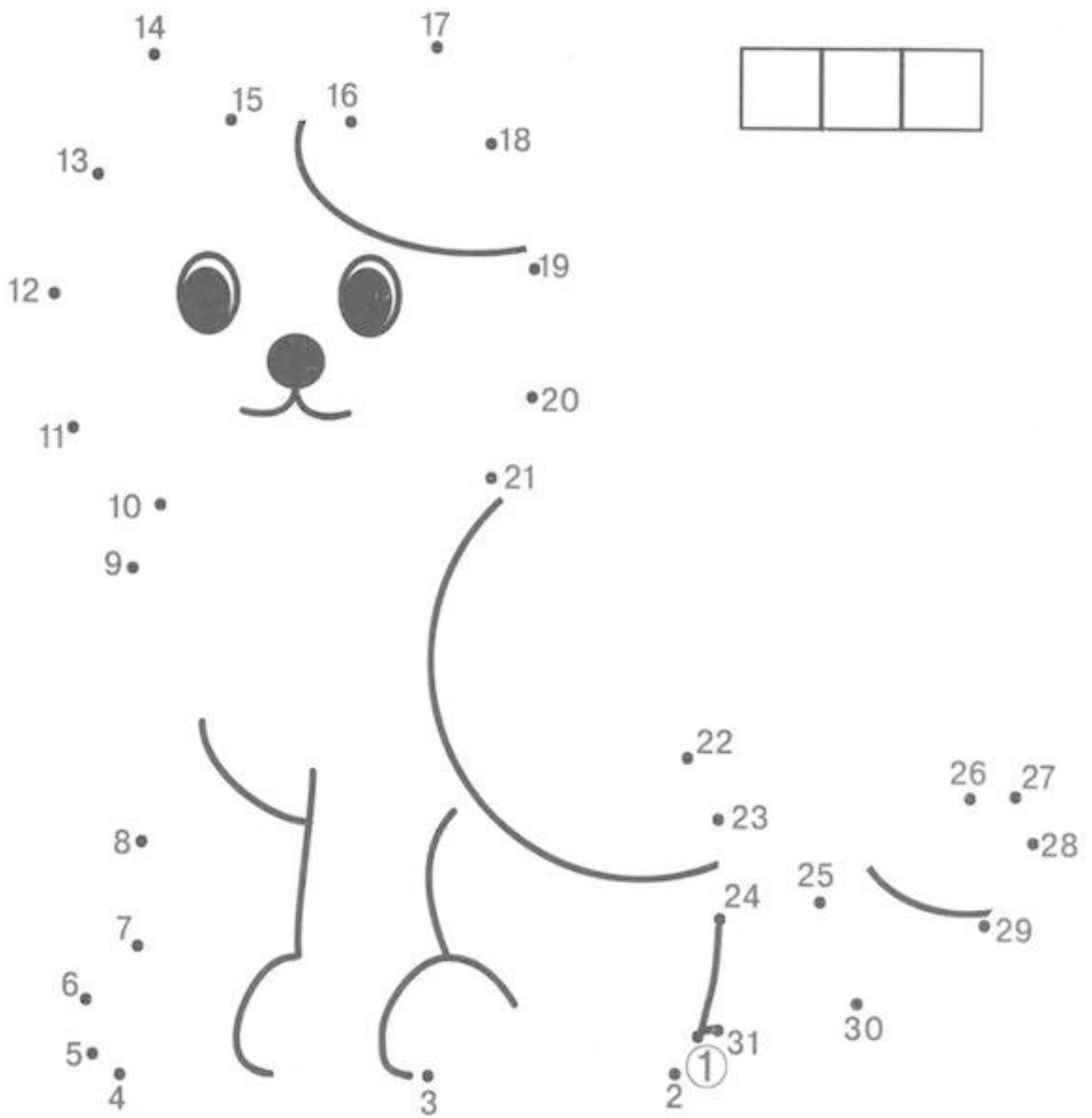

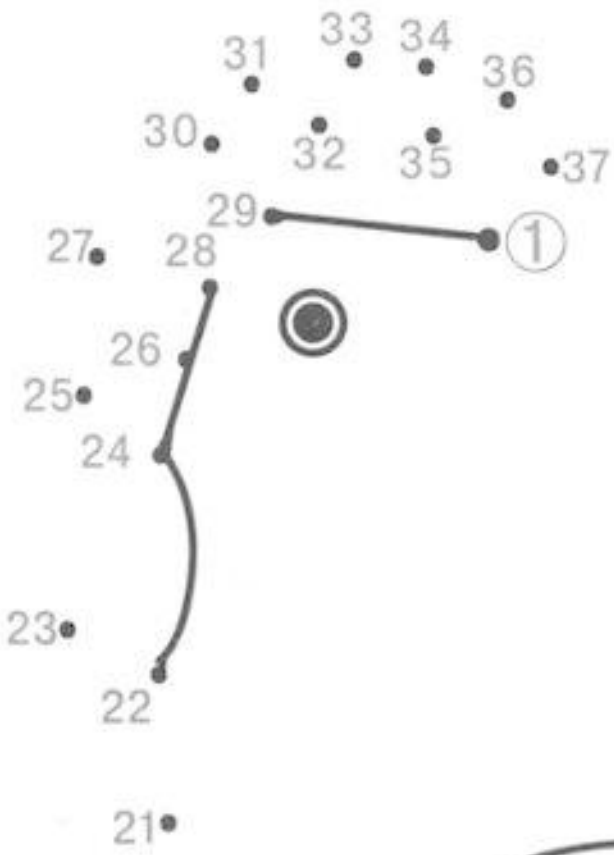
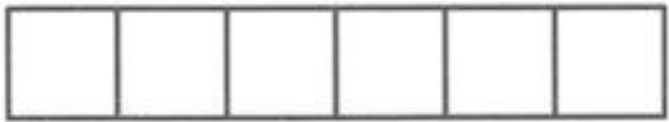

•12

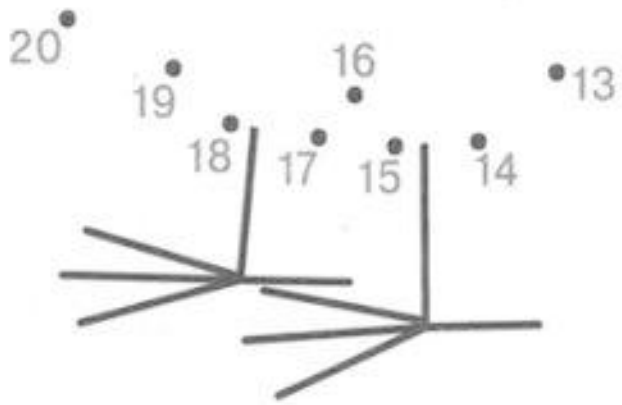

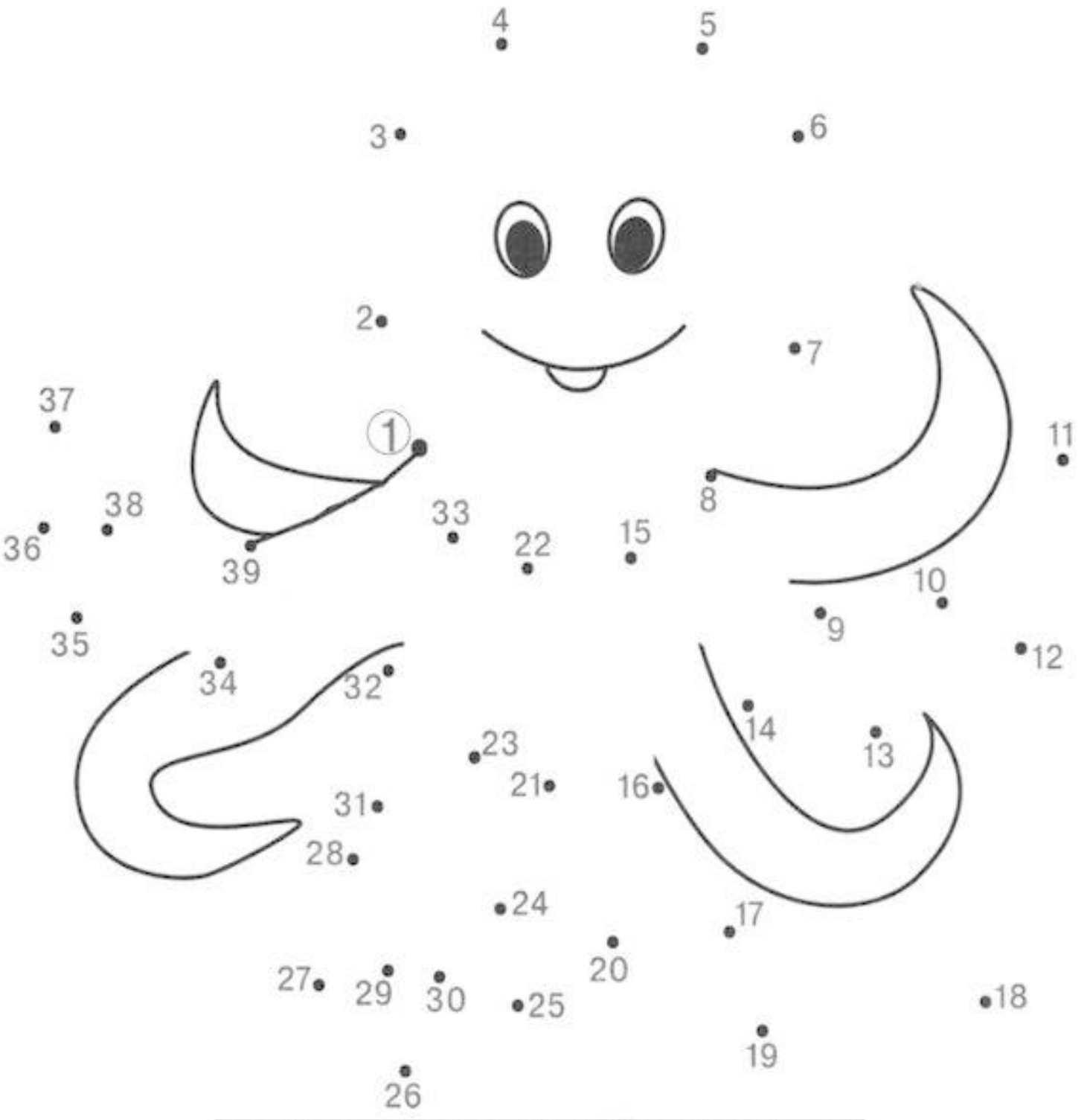

--	--	--	--	--	--	--	--

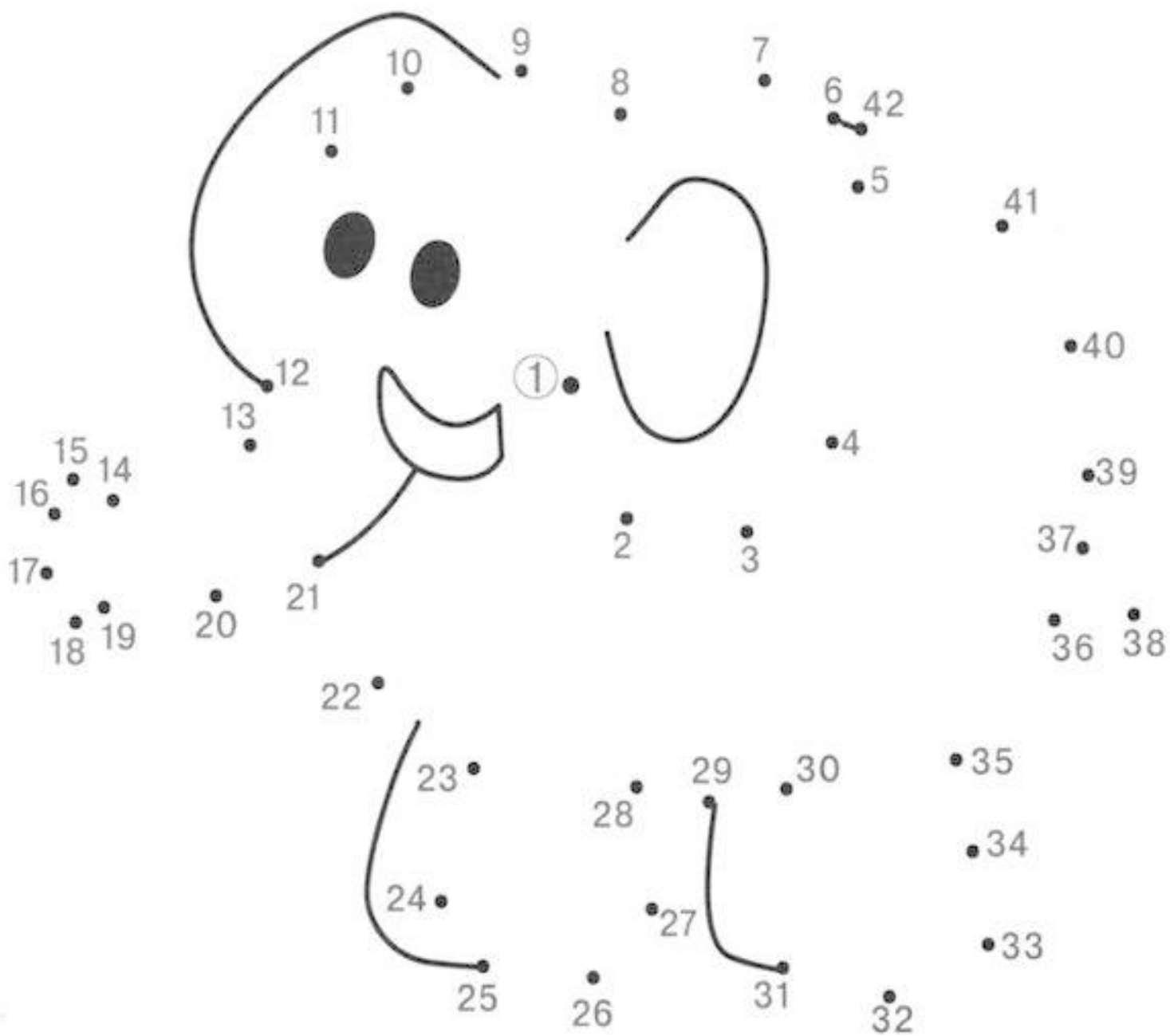

--	--	--	--

